

INSTALLATION INSTRUCTIONS

Neo Hand Shower

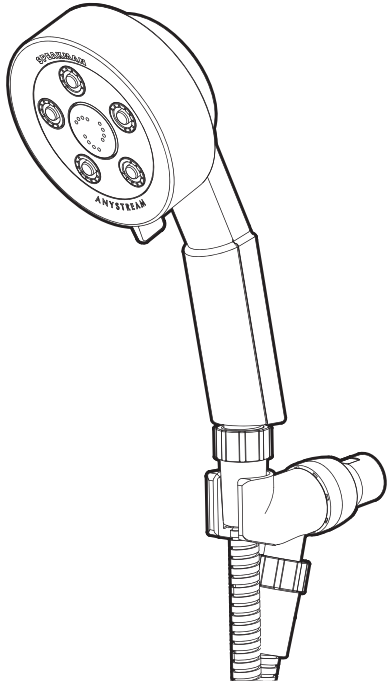

TOOLS & SUPPLIES NEEDED

Thread Seal Tape
(INCLUDED)

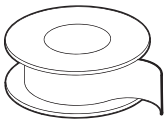

Adjustable
Wrench



IMPORTANT

SAFETY TIPS:

Be sure to read and understand all instructions before beginning installation.

Inspect all connections after installation.

Cover the drain to avoid loss of parts.

Be sure to wear proper eye protection.

Do NOT over tighten any connections or damage may occur.

Shut OFF water supplies before beginning installation.

Observe all local plumbing and building codes.

This product is not equipped with a backflow prevention device. A certified backflow prevention device may need to be installed to your product to make it compliant with the relevant backflow requirements of your local plumbing code or UPC.

MAINTENANCE

Periodic cleaning using a mild soap and warm water will help keep your shower's appearance in its original condition.

For best results, dry immediately with a soft, clean cloth. **DO NOT USE** harsh and/or abrasive cleaners.

To help restore the finish, occasionally apply a non-abrasive wax to your shower (follow manufacturers' instructions).

On CHROME PLATED SHOWERS, a two (2) part white vinegar, one (1) part water solution can be used to break down excessive mineral deposits on the sprays. Let the hand shower soak in the solution for about ½ hour then rinse thoroughly. Brush off any remaining mineral deposits if necessary.

DO NOT USE the vinegar/water treatment on any finish other than Chrome.

APPLY THREAD SEAL TAPE

- 1 Apply the included Thread Seal Tape to the outlet side of shower arm in a clockwise direction.

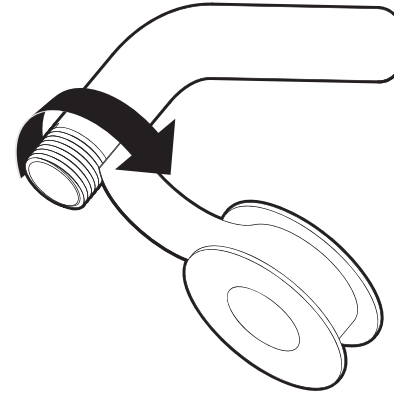

INSTALL BRACKET

- 2 Thread Bracket onto shower arm by turning it in a clockwise direction. Tighten with Adjustable Wrench.

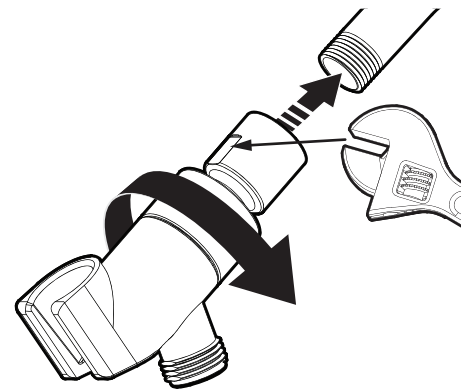

ATTACH HOSE TO BRACKET

- 3 Ensure Hose Washer is inserted inside Hose End to avoid leaks. Thread Hose End to the outlet port of Bracket. Hand tighten.

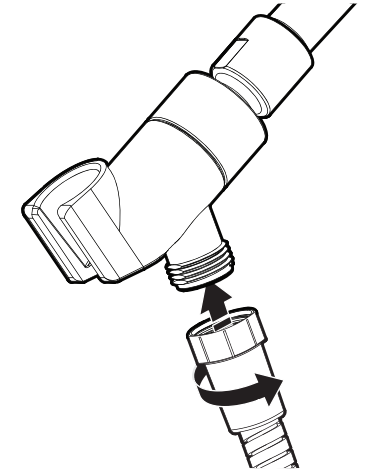

ATTACH HOSE TO HAND SHOWER

- 4 Ensure Hose Washer is inserted inside Hose End to avoid leaks. Thread remaining end of Hose to base of Hand Shower. Hand tighten.

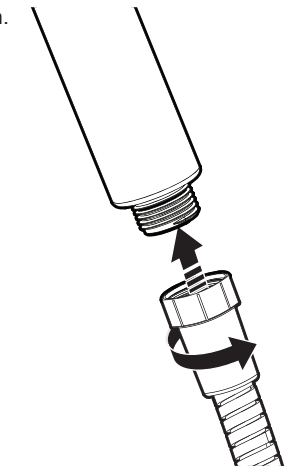

INSPECT FOR LEAKS

- 5** Place Hand Shower into Bracket. Turn on water supply and check for leaks.

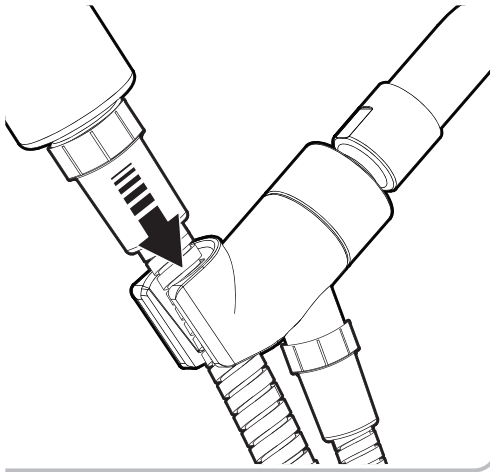

ADJUST SPRAY SETTINGS

- 6** Rotate Spray Face to change Spray Settings.

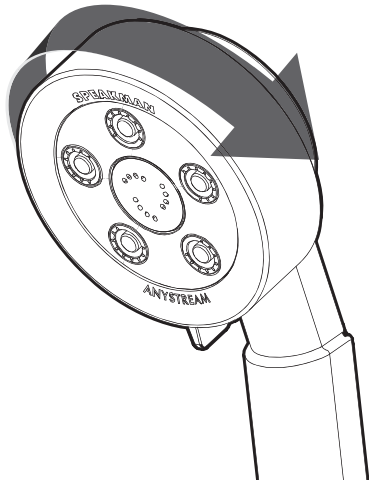

ROUGH IN DIAGRAM

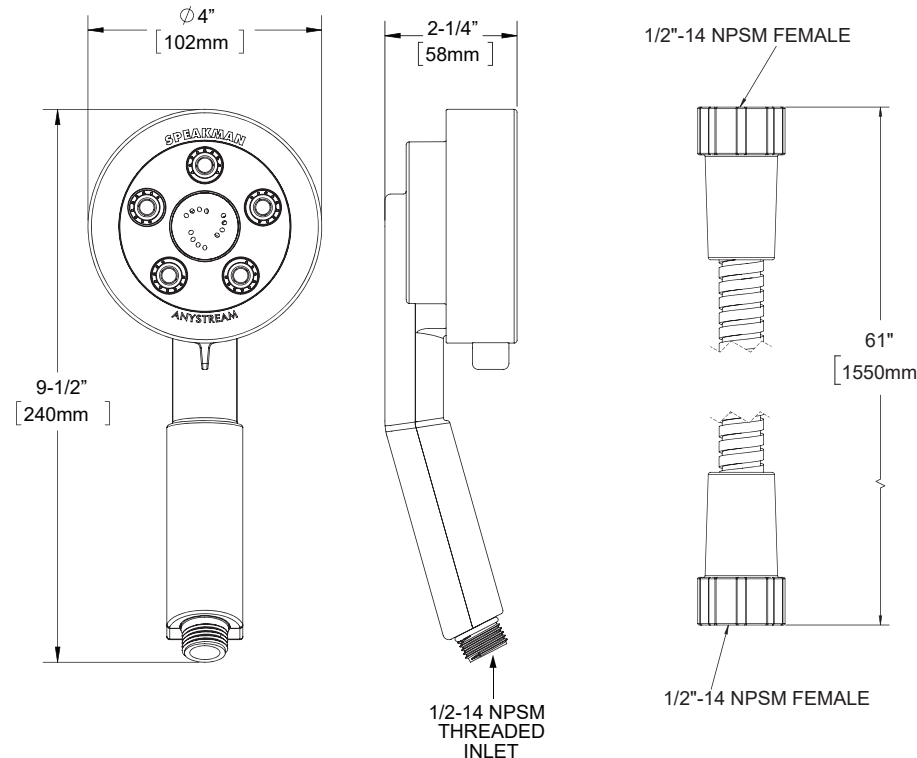

Model: VSR-3010-E2
 Max. Flow Rate: 2.0 gpm (7.6 L/min)
 Min. Flow Rate: 1.75 gpm (6.6 L/min) @ 45psi
 FOR USE WITH AUTOMATIC COMPENSATING VALVES RATED AT
 6.6 L/MIN (1.75 GPM) OR LESS.

Model: VSR-3010-E175
 Max. Flow Rate: 1.75 gpm (6.6 L/min)
 Min. Flow Rate: 1.4 gpm (5.3 L/min) @ 45psi
 FOR USE WITH AUTOMATIC COMPENSATING VALVES RATED AT
 5.3 L/MIN (1.4 GPM) OR LESS.

